

BOTTOM-PLAN VIEW (TOP ONLY)

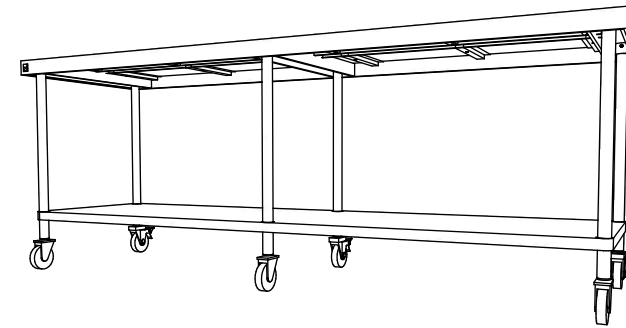

**ISOMETRIC - VIEW
do not scale**

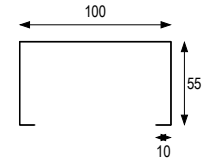

**REINFORCING CHANNEL I
DETAILS**

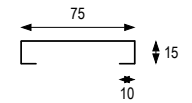

**REINFORCING CHANNEL II
DETAILS**

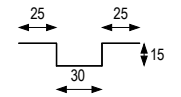

**REINFORCING CHANNEL III
DETAILS**

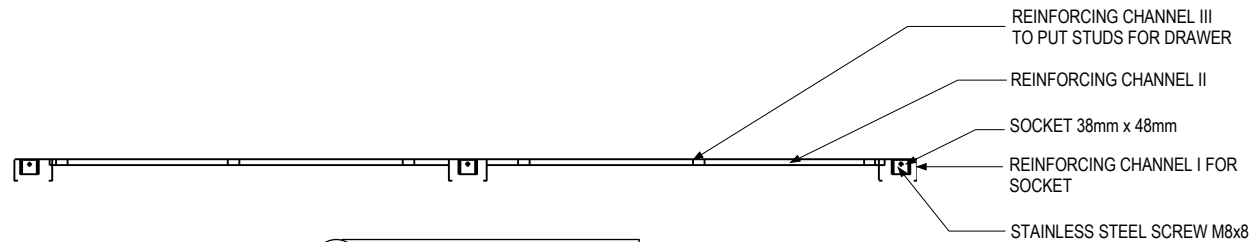

B CONSTRUCTION DETAILS

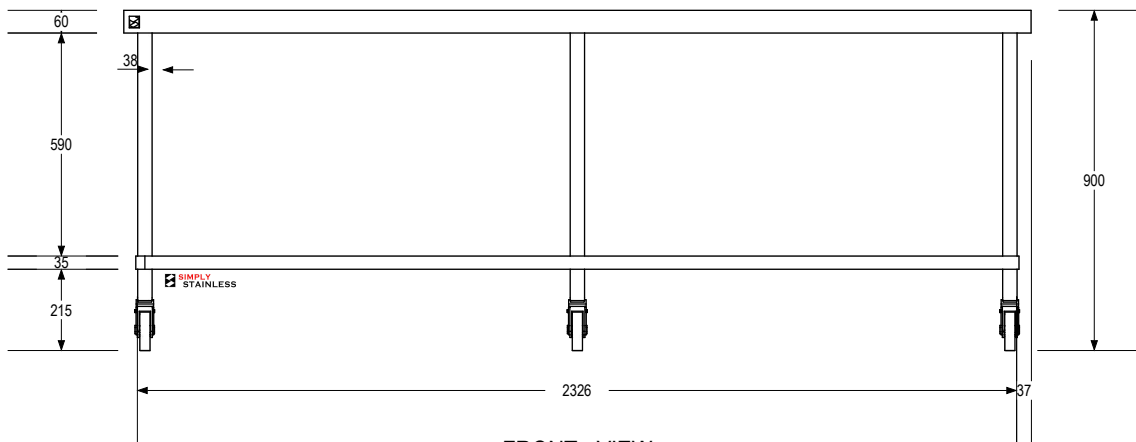

FRONT - VIEW

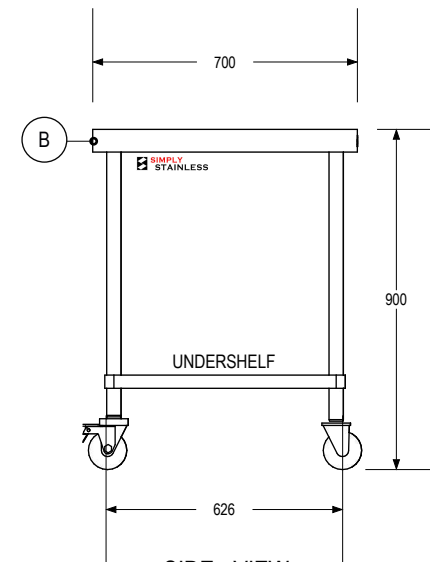

SIDE - VIEW

SIMPLY STAINLESS
www.simplystainless.com
Modular Sinks Tables and Shelving

COPYRIGHT © 2016

This drawing is the property of CI Group Pty Ltd. Trading as SIMPLY STAINLESS and It may not be copied, reproduced or modified in whole or in part without prior written permission of CI Group Pty Ltd. SIMPLY STAINLESS reserves the right to change specification and design without notice.

EU 03-7-2400 MOBILE WORK BENCH

scale 1:20

- FULL SS CONSTRUCTION NOTES :**
1. TOP MADE FROM 1.2mm STAINLESS STEEL.
 2. CHANNEL REINFORCING I , II & III MADE FROM 1.2mm STAINLESS STEEL.
 3. FRAME MADE FROM Ø38mm STAINLESS STEEL TUBE.
 4. UNDERSHELF MADE FROM 1.2mm STAINLESS STEEL.
 5. FEET ARE Ø100mm SWIVEL CASTORS, 3x LOCKING & 3x NON-LOCKING.